

- (A) Colector drenaje 1"
1" Drainage manifold
- (B) Colector entrada 3"
3" Inlet manifold
- (C) Colector salida 3"
3" Outlet manifold

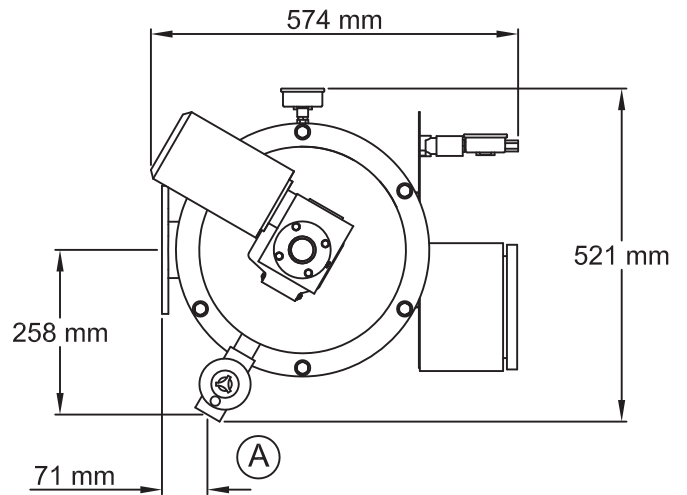

AZUD LUXON LDB 1800 S/3

SCALE S/E A4 FORMAT	MATERIAL:	RESPONS.: M. Martínez	AZUD
	UNITS: mm.	REVISION: 00	
	FILE: Azud_luxon_LDB_1800-S3.dwg	31/05/2011	