

- (A) Colector drenaje 2"  
**2" Drainage manifold**
- (B) Colector entrada 12"  
**12" Inlet manifold**
- (C) Colector salida 12"  
**12" Outlet manifold**

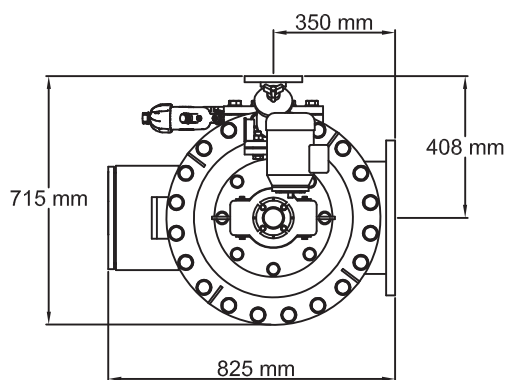

### AZUD LUXON LDB 10600 S/12

SCALE S/E A4 FORMAT	MATERIAL:	RESPONS.: M. Martínez	<b>AZUD</b>
	UNITS: mm.	REVISION: 00	
	FILE: Azud_luxon_LDB_10600-S12.dwg	04/05/2012	